

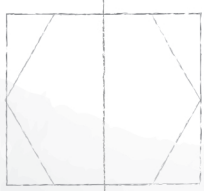

*Thread protection*

PROTEZIONE  
FILETTI

8,5mm



10 mm

# PROTEZIONE FILETTI

Thread protection

## THREADED PROTECTIONS



PARALLEL PLUGS FOR  
THREADS  
Pag. 4



PARALLEL PROTECTION PLUG  
Pag. 5



THREADED UNIVERSAL PLUG  
Pag. 9



PRESSION THREADED  
UNIVERSAL PLUG  
Pag. 11



THREADED PLUGS  
Pag. 12



SEALING THREADED PLUG  
Pag. 13



THREADED PLUGS WITH O-  
RING  
Pag. 15



ANTI-VIBRATION PLUGS  
Pag. 17



EAR PLUG  
Pag. 18



PIPES, FLANGES, VALVES AND  
PROTECTION CAPS  
Pag. 19



THREADED PLUGS FOR  
ELECTRICAL PANELS  
Pag. 22



SNAP-FIT  
Pag. 23



QUICK-FIT THREADED PLUG  
Pag. 24



SOFT END CAPS  
Pag. 25



THREADED CAPS  
Pag. 29



QUICK THREADED CAPS  
Pag. 31



THREADED CAPS WITH SEAL  
Pag. 32



THREADED SEALING CAPS  
Pag. 34



HEXAGONAL CAPS  
Pag. 36



PULL-TAB CAPS  
Pag. 37



PVC PULL TAB  
Pag. 38



PVC CAP  
Pag. 40



QUICK-FIT QUICK-RELEASE  
CAP  
Pag. 41



FINNED CAPS  
Pag. 42

## THREADED PROTECTIONS



RED CAPS  
Pag. 43



LARGE HEAD HIGH CAPS  
Pag. 44

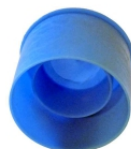

ORF CAPS  
Pag. 45



PULL-TAB HOSE PLUGS  
Pag. 46



PRESSION PLUG  
Pag. 47



PRESSION PLUGS WITH 1  
INSERT  
Pag. 48



PRESSION PLUGS WITH 2  
INSERTS  
Pag. 49



PUSH-IN PLUGS  
Pag. 50



PUSH-IN PLUGS TYPE 2  
Pag. 51

## PARALLEL PLUGS FOR THREADS

DESCRIPTION	
<b>MATERIAL</b>	POLYTHENE (LDPE)
<b>COLOR</b>	RED
<b>NOTE</b>	GAS column also valid for type thread BSP and NPT

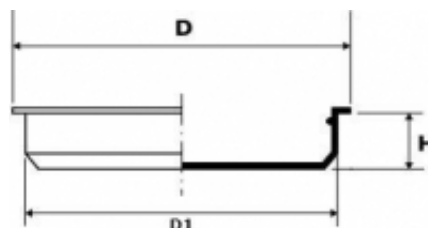

CODE	D	D1	H	GAS
STG1/8	11,5	9	7,5	1/8"
STG1/4	14,5	12	9	1/4"
STG3/8	18,5	15,5	9,5	3/8"
STG1/2	22	19	10	1/2"
STG5/8	24,5	21	11	5/8"
STG3/4	30	25	11	3/4"
STG7/8	32	28,5	10	7/8"
STG1	36	31	10,5	1"
STG1.1/4	43,3	39,5	10,7	1.1/4"
STG1.1/2	50,8	46	10	1.1/2"
STG2	65	58	11	2"

## PARALLEL PROTECTION PLUG

DESCRIPTION	
<b>MATERIAL</b>	POLYTHENE (PE - LD)
<b>COLOR</b>	NATURAL
<b>NOTE</b>	GAS column also valid for type thread BSP

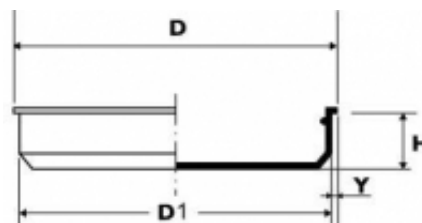

CODE	D	D1	H	Y	GAS	DN
ST002	6,5	2	3	2,25	-	-
ST002,5	6,5	2,5	3,5	2	-	-
ST003	6,5	3	4,5	1,75	-	-
ST003,5	7	3,5	4,5	1,75	-	-
ST004	7,5	4	5	1,75	-	-
ST004,5	8	4,5	5	1,75	-	-
ST005	9	5	6	2	-	-
ST005,5	9	5,5	6	1,75	-	-
ST006	9,5	6	6	1,75	-	-
ST006,5	10	6,5	7	1,75	-	-
ST007	10	7	6	1,50	-	-
ST007,5	10,5	7,5	6,5	1,50	-	-
ST008	11	8	7	1,50	-	-
ST008,5	11,5	8,5	7,5	1,50	-	-
ST009	12	9	7,5	1,50	1/8"	-
ST009,5	12,5	9,5	7,5	1,50	-	-
ST010	13	10	8,5	1,50	-	-
ST010,5	13,5	10,5	8,5	1,50	-	DN10
ST011	14,5	11	8,5	1,75	-	-
ST011,5	14,5	11,5	8,5	1,50	-	-
ST012	14,5	12	9	1,25	1/4"	-
ST012,5	15,5	12,5	9	1,50	-	-
ST013	16,5	13	9,5	1,75	-	-
ST013,5	16,5	13,5	9,5	1,50	-	-
ST014	17,5	14	10	1,75	-	-
ST014,5	17,5	14,5	9,5	1,50	-	-
ST015	18	15	9,5	1,50	-	-
ST015,5	18,5	15,5	9,5	1,50	3/8"	DN15
ST016	19,5	16	10	1,75	-	-
ST016,5	19,5	16,5	10,5	1,50	-	-
ST017	20,5	17	10,5	1,75	-	-
ST017,5	21	17,5	10,5	1,75	-	-
ST018	21,5	18	10,5	1,75	-	-

CODE	D	D1	H	Y	GAS	DN
ST018,5	23	18,5	10	2,25	-	-
ST019	22	19	10	1,50	1/2"	-
ST019,5	23	19,5	10,5	1,75	-	-
ST020	23,5	20	11	1,75	-	-
ST020,5	24,5	20,5	10,5	2	-	DN20
ST021	24,5	21	11	1,75	5/8"	-
ST021,5	25,5	21,5	11	2	-	-
ST022	25,5	22	11	1,75	-	-
ST022,5	26	22,5	10,5	1,75	-	-
ST023	27	23	10,5	2	-	-
ST023,5	27,5	23,5	10,5	2	-	-
ST024	28	24	11,5	2	-	-
ST024,5	28	24,5	10,5	1,75	3/4"	-
ST025	30	25	11	2,50	3/4"	-
ST025,5	29	25,5	10,5	1,75	-	DN25
ST026	30,5	26	10,5	2,25	-	-
ST026,5	30	26,5	10,5	1,75	-	-
ST027	31	27	9,5	2	-	-
ST027,5	31	27,5	10,5	1,75	-	-
ST028	32,5	28	10,5	2,25	-	-
ST028,5	32	28,5	10	1,75	7/8"	-
ST029	32	29	9,5	1,50	-	-
ST029,5	33	29,5	10,5	1,75	-	-
ST030	33	30	10	1,50	-	-
ST030,5	34	30,5	10	1,75	-	-
ST031	36	31	10,5	2,50	1"	-
ST031,5	35	31,5	10,5	1,75	-	-
ST032	37	32	10,5	2,50	-	-
ST032,5	37,5	32,5	10,5	2,50	-	DN32
ST033	38	33	10,5	2,50	-	-
ST033,5	37,5	33,5	10,5	2	-	-
ST034	38,5	34	10,5	2,25	-	-
ST034,5	38	34,5	10,5	1,75	-	-
ST035	40	35	10,5	2,50	-	-
ST035,5	39	35,5	10,5	1,75	-	-
ST036	41	36	11	2,50	-	-
ST036,5	40	36,5	10,5	1,75	-	-
ST037	42	37	11	2,50	-	-
ST037,5	41,5	37,5	10,5	2	-	-
ST038	43	38	10,5	2,50	-	-
ST038,5	42	38,5	10,5	1,75	-	-
ST039	44	39	10,5	2,50	-	-
ST039,5	43,3	39,5	10,7	1,90	1.1/4"	-
ST040	45	40	10,5	2,50	-	-
ST041	46	41	10,5	2,50	-	DN40
ST042	46,5	42	10,5	2,25	-	-
ST043	47,8	43	10,7	2,40	-	-
ST044	49	44	10,5	2,50	-	-
ST045	50,8	45	10,6	2,90	-	-
ST046	50,8	46	10	2,40	1.1/2"	-
ST047	51,5	47	10,5	2,25	-	-
ST048	53	48	10,5	2,50	-	-
ST048,5	52	48,5	10,5	1,75	-	-
ST049	54,5	49	11	2,25	-	-
ST050	54	50	10	2	-	DN50
ST051	56	51	11	2,50	-	-
ST052	57,5	52	11	2,75	-	-

CODE	D	D1	H	Y	GAS	DN
ST053	59	53	11	3	-	-
ST53,5	55,5	53,5	9,5	1	-	-
ST054	61	54	11	3,5	-	-
ST055	61	55	10	3	-	-
ST056	63	56	11,5	3,5	-	-
ST056,5	59,5	56,5	10,5	1,50	-	-
ST057	61	57	10	2	2"	-
ST058	65	58	11	3,5	2"	-
ST059	65	59	11	3	-	-
ST060	65	60	11	2,50	-	-
ST061	67,5	61	11	3,25	-	-
ST062	68	62	11	3	-	-
ST063	67	63	9,5	2	-	-
ST063,5	70	63,5	10,5	3,25	-	-
ST064	67,5	64	9,5	1,75	-	-
ST065	69	65	10	2	-	DN65
ST066	72	66	10	3	-	-
ST067	73	67	10	3	-	-
ST068	75	68	11	4	-	-
ST069	75	69	10,5	3	-	-
ST070	74	70	11	2	-	-
ST071	74,5	71	11	1,75	-	-
ST71,5	74,5	71,5	10,5	1,50	-	-
ST072	79	72	12	3,5	-	-
ST073	76,5	73	9,5	1,75	-	-
ST074	77,5	74	10,5	1,75	2.1/2"	-
ST075	79	75	9,5	2	-	-
ST076	80	76	10,5	2	-	-
ST077	81	77	9,5	2	-	-
ST078	82	78	10,5	2	-	-
ST079	83	79	9,6	2	-	-
ST080	84	80	9,5	2	-	DN80
ST081	85	81	9,5	2	-	-
ST082	85,5	82	9,5	1,75	-	-
ST083	86,5	83	9,5	1,75	-	-
ST084	90	84	10	2	-	-
ST84,5	90	84,5	8	2,75	-	-
ST085	88,5	85	9,5	1,75	-	-
ST086	90	86	9,5	2	-	-
ST86,5	89	86,5	10	1,25	-	-
ST087	90,5	87	9,5	1,75	-	-
ST088	91,5	88	9,5	1,75	-	-
ST089	92,5	89	9,5	1,75	-	-
ST090	92,5	90	10	1,25	-	-
ST091	93	91	9,5	1	-	-
ST092	94,5	92	9,5	1,25	-	-
ST093	97	93	9,5	2	-	-
ST094	97	94	9,5	1,5	-	-
ST095	97	95	9	1	-	-
ST096	98	96	9,5	1	-	-
ST097	99	97	9,5	1	-	-
ST098	100	98	10	1	-	-
ST099	102	99	9,5	1,5	-	-
ST100	104,5	100	10,5	2,25	-	-
ST101	105	101	10,5	2	-	-
ST102	106	102	10,5	2	-	-
ST103	106	103	11	1,5	-	-

CODE	D	D1	H	Y	GAS	DN
ST104	106,5	104	11	1,25	-	-
ST105	108	105	10,5	1,50	-	-
ST106	109,5	106	10,5	1,75	-	-
ST107	110	107	10,5	1,50	-	-
ST108	111,5	108	10,5	1,75	-	-
ST110	114	110	12,5	2	-	-
ST111	115	111	12,7	2	4"	-
ST112	116	112	10,5	2	-	-
ST115	118,5	115	12	1,75	-	-
ST117	124	117	12	1,75	-	-
ST121	124	121	12	1,50	-	-
ST125	130	125	13,5	2,50	-	-
ST128	132	128	13,5	2,50	-	2
ST130	134	130	13,5	2	-	-
ST132	136,5	132	13	2,25	-	-
ST135	141	135	12,5	3	-	-
ST140	144	140	13,5	2	-	-
ST142	146	142	13,5	2	-	-
ST146	152	146	12	3	-	-
ST150	154	150	14,5	2	-	-
ST152	156	152	15	2	-	-
ST155	161	155	12	3	-	-
ST160	167	160	14	3,5	-	-
ST162	169	162	14	3,5	-	-
ST165	171	165	12	3	-	-
ST167	178	167	12,7	5,5	-	-
ST169	175	169	12	3	-	-
ST170	175,6	170	13,6	2,8	-	-
ST172	177,6	172	13,6	2,8	-	-
ST176	182	176	12	3	-	-
ST180	187	180	14,5	3,5	-	-
ST182	189	182	14,5	3,5	-	-
ST184	194	184	16	5	-	-
ST186	194	186	16	4	-	-
ST190	195,6	190	13,6	2,8	-	-
ST192	197,6	192	13,6	2,8	-	-
ST200	208	200	14	4	-	-
ST202	210	202	14	4	-	-
ST204	208	204	14,2	2	-	-
ST208	220	208	15	6	-	-
ST211	217	211	12	3	-	-
ST214	220	214	13,5	3	-	-
ST221	227	221	12	3	-	-
ST230	236	230	12	3	-	-
ST232	242,6	232	13,5	5,3	-	-
ST233	245	233	16	6	-	-
ST250	259	250	14,5	4,5	-	-
ST252	261	252	14,5	4,5	-	-
ST261	273	261	16	2	-	-
ST285	298	285	18	6,5	-	-
ST302	309,6	302	18,5	3,8	-	-
ST311	324	311	18	6,5	-	-
ST390	400	390	19	5	-	-



## THREADED UNIVERSAL PLUG

DESCRIPTION	
<b>MATERIAL</b>	POLYTHENE
<b>COLOR</b>	RED
<b>NOTE</b>	GAS column also valid for type thread UNF

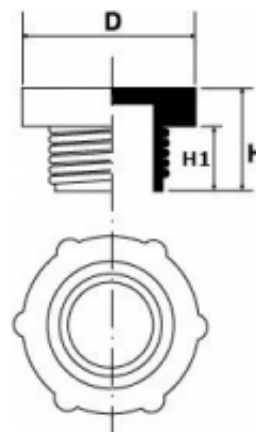

CODE	D	H	H1	THREAD	GAS	UNF	PITCH
TFU1/8	16,4	10,5	4,2		1/8"		28
TFU1/4	18,8	12,8	6,5		1/4"		19
TFU3/8	22,9	12	5,5		3/8"		19
TFU1/2	28	17,3	10,3		1/2"		14
TFU5/8	31,3	18,4	13,9		5/8"		14
TFU3/4	32,3	17	11		3/4"		14
TFU7/8	38	18,1	13,5		7/8"		14
TFU1	39,8	16,9	10,8		1"		11
TFU1.1/4	49,9	20,9	15		1.1/4"		11
TFU1.1/2	55,2	16,9	10,8		1.1/2"		11
TFU2	73,7	17,5	10,7		2"		11
TFU3	105	16,5	11,3		3"		11
TFU8X1	12,3	14,3	9,5	M8			1
TFU10X1	15,3	14,6	10,4	M10			1
TFU12X1	18,5	16,7	10,7	M12			1
TFU12X1.5	16,7	16,3	8,7	M12			1,5
TFU14X1.5	18,5	17,2	9,5	M14			1,5
TFU16X1.5	22	17,2	12,5	M16			1,5
TFU18X1.5	24,4	18,3	13,7	M18			1,5
TFU20X1.5	26,3	18,2	14	M20			1,5
TFU22X1.5	28,2	18,3	13,7	M22			1,5
TFU24X1.5	31,3	18,5	13,8	M24			1,5
TFU25X1.5	31,3	18,5	14	M25			1,5
TFU26X1.5	32,7	18,7	13,8	M26			1,5
TFU52X1.5	63,7	21,5	15,5	M52			1,5
TFU5/16UX18	14,5	12	7,4			5/16"	18
TFU5/16UX24	14,8	12,3	7,4			5/16"	24
TFU3/8UX24	13,7	14	9,5			3/8"	24
TFU7/16UX20	17,4	16,1	11			7/16"	20
TFU7/16UX24	17,8	12,1	7,1			7/16"	24

CODE	D	H	H1	THREAD	GAS	UNF	PITCH
TFU1/2UX20	18,5	15,3	10,5			1/2"	20
TFU9/16UX18	22,6	15,4	10,7			9/16"	18
TFU9/16UX24	18,9	13,6	9			9/16"	24
TFU5/8UX18	21	14,8	10			5/8"	18
TFU5/8UX24	20,7	14,8	10			5/8"	24
TFU11/16UX16	25,6	18,1	13,5			11/16"	16
TFU3/4UX16	27	18,7	13,8			3/4"	16
TFU13/16UX16	26,7	18,1	13,5			13/16"	16
TFU7/8UX14	28,8	18,5	13,6			7/8"	14
TFU1UX14	32	17,8	13,2			1"	14
TFU1.1/16UX12	33,4	18,4	13,8			1.1/16"	12
TFU1.1/16UX14	33,3	18,3	13,7			1.1/16"	14
TFU1.3/16UX12	36,8	18,3	13,5			1.3/16"	12
TFU1.5/16U	39,3	16,3	11			1.5/16"	12
TFU1.5/8UX12	50,6	17,3	12,9			1.5/8"	12
TFU1.3/4UX12	53,2	19,7	13,8			1.3/4"	12
TFU1.7/8UX12	58,4	22,5	16,7			1.7/8"	12
TFU2.1/2UX12	73,6	20,6	15			2.1/2"	12

## PRESSION THREADED UNIVERSAL PLUG

DESCRIPTION	
<b>MATERIAL</b>	POLYTHENE (LDPE)
<b>COLOR</b>	RED
<b>NOTE</b>	GAS column also valid for type thread UNF and NPT

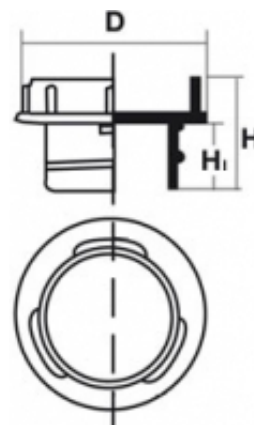

CODE	D	H	H1	THREAD	GAS	UNF
TFUP1/8	14,3	6	3,5	M10	1/8"	
TFUP1/4	17,6	8,1	5,3	M12	1/4"	1/2"
TFUP3/8	21,7	8	5,4	M16	3/8"	
TFUP1/2	26	9,3	5,6	M20	1/2"	
TFUP5/8	27,5	13,7	9,7	M22	5/8"	7/8"
TFUP3/4	31,4	10,8	5,9		3/4"	
TFUP1	37,6	12,8	5,2		1"	
TFUP1.1/4	49,5	10,1	5		1.1/4"	
TFUP1.1/2	55	12,8	5		1.1/2"	
TFUP2	68	22	8		2"	
TFUP1,1/16U	31,4	5,9	5,9	M26		1.1/16"

## THREADED PLUGS

DESCRIPTION	
<b>MATERIAL</b>	POLYTHENE (HDPE)
<b>COLOR</b>	YELLOW
<b>NOTE</b>	

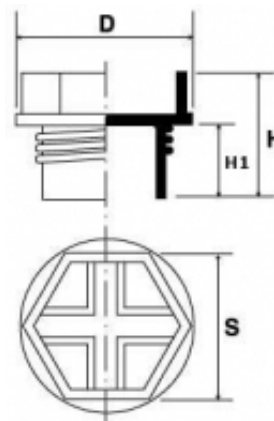

CODE	D	H	H1	S	THREAD	GAS	PITCH
TF1/8	14	16	9	12		1/8"	28
TF1/4	19	17	9	16		1/4"	19
TF3/8	21	19	10	18		3/8"	19
TF1/2	26	21	12	21,5		1/2"	14
TF3/4	32	21	12	27,5		3/4"	14
TF1	40	21	12	33,5		1"	11
TF1.1/4	49	21	12	44		1.1/4"	11
TF8X1	12	14	7	10	M8		1
TF10X1	14	16	9	12	M10		1
TF12X1	16	16	9	13	M12		1
TF14X1	19	17	9	16	M14		1
TF12X1,5	16	17	9	13	M12		1,5
TF14X1,5	19	17	9	16	M14		1,5
TF16X1,5	21	19	10	18	M16		1,5
TF18X1,5	24	19	10	20	M18		1,5
TF20X1,5	26	21	12	22	M20		1,5

## SEALING THREADED PLUG

DESCRIPTION	
<b>MATERIAL</b>	NYLON 6.6
<b>COLOR</b>	YELLOW
<b>NOTE</b>	GAS column also valid for type thread UNF and BSP

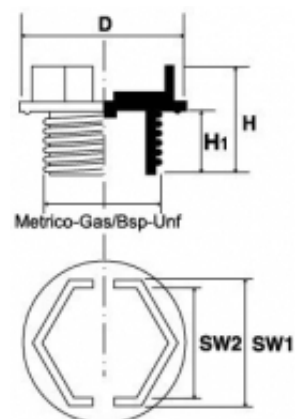

CODE	D	H	H1	THREAD	GAS	UNF	SW1	SW2	PITCH
TFT8X1	12,5	15,5	8	M8	-	-	7	4	1
TFT10X1	14,5	16,5	9	M10	-	-	9	6	1
TFT12X1	17	16,5	9	M12	-	-	10	7	1
TFT12X1.5	17	16,5	9	M12	-	-	10	7	1,5
TFT14X1.5	19	17,5	10	M14	-	-	13	10	1,5
TFT16X1.5	22	17,5	10	M16	-	-	15	12	1,5
TFT18X1.5	24	17,5	10	M18	-	-	17	14	1,5
TFT20X1.5	26	17,5	10	M20	-	-	19	16	1,5
TFT22X1.5	28	17,5	10	M22	-	-	21	18	1,5
TFT24X1.5	30	17,5	10	M24	-	-	24	21	1,5
TFT26X1.5	32	20,5	12	M26	-	-	24	21	1,5
TFT27X1.5	33	20,5	12	M27	-	-	24	21	1,5
TFT28X1.5	34	20,5	12	M28	-	-	24	21	1,5
TFT30X1.5	38	20,5	12	M30	-	-	24	21	1,5
TFT32X1.5	40	20,5	12	M32	-	-	24	21	1,5
TFT36X1.5	45	20,5	12	M36	-	-	24	21	1,5
TFT38X1.5	48	20,5	12	M38	-	-	24	21	1,5
TFT45X1.5	52	21,5	12	M45	-	-	30	27	1,5
TFT52X1.5	60	22	12	M52	-	-	30	27	1,5
TFT27X2	33	22	13,5	M27	-	-	24	21	2
TFT30X2	38	22	13,5	M30	-	-	24	21	2
TFT33X2	40	22	13,5	M33	-	-	24	21	2
TFT36X2	45	22	13,5	M36	-	-	24	21	2
TFT42X2	50	22	13,5	M42	-	-	30	27	2
TFT48X2	55	23	13,5	M48	-	-	30	27	2
TFT52X2	60	23	13,5	M52	-	-	30	27	2
TFT1/8	16	15,5	8		1/8"	-	12	9	28
TFT1/4	19	17,5	10		1/4"	-	13	10	19
TFT3/8	22	17,5	10		3/8"	-	15	12	19
TFT1/2	27	19,5	12		1/2"	-	19	16	14

CODE	D	H	H1	THREAD	GAS	UNF	SW1	SW2	PITCH
TFT5/8	29,5	19,5	12		5/8"	-	22	19	14
TFT3/4	32	19,5	12		3/4"	-	24	21	14
TFT7/8	37	19,5	12		7/8"	-	27	24	14
TFT1	40	22,5	15		1"	-	30	27	11
TFT1.1/4	50	22,5	15		1.1/4"	-	36	33	11
TFT1.1/2	56	24	15		1.1/2"	-	41	37	11
TFT1.3/4	62	24	15		1.3/4"	-	50	46	11
TFT2	68	24	15		2"	-	55	51	11
TFT3/8X24	16	17,5	10		-	3/8"	9	6	24
TFT7/46X20	17	17,5	10		-	7/16"	10	7	20
TFT3/8X24	19	17,5	10		-	3/8"	13	10	24
TFT9/16X18	20,5	17,5	10		-	9/16"	13	10	18
TFT5/8X18	22	17,5	10		-	5/8"	15	12	18
TFT3/4X16	26	17,5	10		-	3/4"	19	16	16
TFT7/8X14	28,5	19,5	12		-	7/8"	21	18	14
TFT1X14	31,5	19,5	12		-	1"	24	21	14
TFT1.1/16X12	33	19,5	12		-	1.1/16"	24	21	12
TFT1.3/16X12	36,5	22,5	15		-	1.3/16"	30	27	12
TFT1.5/16X12	40	22,5	15		-	1.5/16"	30	27	12
TFT1.5/8X12	47,5	22,5	15		-	1.5/8"	36	33	12
TFT1.7/8X12	54	22,5	15		-	1.7/8"	36	33	12

## THREADED PLUGS WITH O-RING

DESCRIPTION	
<b>MATERIAL</b>	Polyethylene
<b>COLOR</b>	YELLOW
<b>NOTE</b>	GAS column also valid for type thread UNF

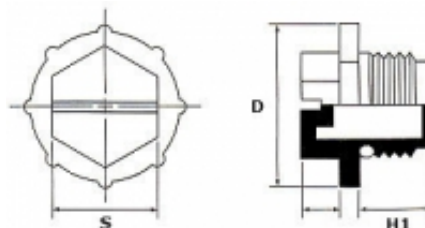

CODE	D	H	H1	S	THREAD	GAS	UNF	PITCH
TFTOR1/8X28	16	17,2	10	7		1/8"		28
TFTOR1/4X19	19	19,7	12,5	10		1/4"		19
TFTOR3/8X19	22	20,9	12,5	13		3/8"		19
TFTOR1/2X14	27	21,9	13,5	15		1/2"		14
TFTOR5/8"X14	29,5	21,9	13,5	17		5/8"		14
TFTOR3/4X14	32	21,9	13,5	19		3/4"		14
TFTOR7/8X14	37	21,9	13,5	22		7/8"		14
TFTOR1X11	40	23,6	15	24		1"		11
TFTOR1.1/4X1 1	50	23,6	15	24		1.1/4"		11
TFTOR1.1/2X1 1	56	25	15	30		1.1/2"		11
TFTOR1.3/4X1 1	62	25	15	36		1.3/4"		11
TFTOR2X11	68	25	15	36		2"		11
TFTORM8X1	12,5	17	10	6	M8			1
TFTORM10X1	14,5	17,2	10	7	M10			1
TFTORM12X1	17	17,2	10	10	M12			1
TFTORM10X1. 5	14,5	19,2	12	7	M10			1,5
TFTORM12X1. 5	17	19,2	12	10	M12			1,5
TFTORM14X1. 5	22	19,2	12	10	M14			1,5
TFTORM16X1. 5	24	20,4	12	13	M16			1,5
TFTORM18X1. 5	24	20,4	12	13	M18			1,5
TFTORM20X1. 5	26	20,4	12	15	M20			1,5
TFTORM22X1. 5	28	20,4	12	15	M22			1,5
TFTORM24X1. 5	30	20,4	12	17	M24			1,5

CODE	D	H	H1	S	THREAD	GAS	UNF	PITCH
TFTORM26X1.5	32	20,4	12	19	M26			1,5
TFTORM28X1.5	34	20,4	12	19	M28			1,5
TFTORM30X1.5	38	20,6	12	22	M30			1,5
TFTORM32X1.5	40	20,6	12	24	M32			1,5
TFTORM36X1.5	45	20,6	12	24	M36			1,5
TFTORM38X1.5	48	20,6	12	24	M38			1,5
TFTORM45X1.5	52	22	12	24	M45			1,5
TFTORM52X1.5	60	22	12	30	M52			1,5
TFTORM27X2	33	24,6	15	19	M27			2
TFTORM30X2	38	24,6	15	22	M30			2
TFTORM33X2	40	24,6	15	24	M33			2
TFTORM36X2	45	24,6	15	24	M36			2
TFTORM42X2	50	24,6	15	24	M42			2
TFTORM45X2	52	25	15	30	M45			2
TFTORM48X2	55	25	15	30	M48			2
TFTORM52X2	60	25	15	7	M52			2
TFTOR3/8X24U	14	17,2	10	7			3/8"	24
TFTOR1/16X20U	16	19,7	12,5	10			1/16"	20
TFTOR1/2X20U	19	20,9	12,5	10			1/2"	20
TFTOR9/16X18U	21	20,9	12,5	10			9/16"	18
TFTOR5/8X18U	22	20,9	12,5	13			5/8"	18
TFTOR3/4X16U	27	21,9	13,5	13			3/4"	16
TFTOR7/8X14U	28	21,9	13,5	15			7/8"	14
TFTOR1X14U	31	22,1	13,5	17			1"	14
TFTOR11/16X12U	35	22,6	14	19			1.1/16"	12
TFTOR13/16X12U	38	22,6	14	22			1.3/16"	12
TFTOR15/16X12U	42	24	14	24			1.5/16"	12
TFTOR15/8X12U	50	24	14	24			1.5/8"	12
TFTOR17/8X12U	55	24	14	30			1.7/8"	12



## ANTI-VIBRATION PLUGS

DESCRIPTION	
<b>MATERIAL</b>	LDPE
<b>COLOR</b>	NATURAL
<b>NOTE</b>	GAS column also valid for type thread BSP Notched thread design prevents part coming loose due to vibration Transparent colour allows easy inspection of o-ring Plug keeps fitting tight against tube collar

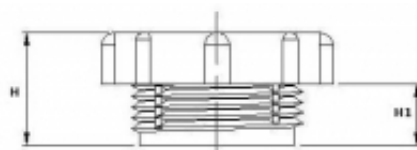

CODE	H	H1	GAS	PITCH
TFAV1/4	11	5	1/4"	19
TFAV3/8	12,8	6,8	3/8"	19
TFAV1/2	13,3	7,3	1/2"	14
TFAV5/8	16,5	10,5	5/8"	14
TFAV3/4	15,6	9,6	3/4"	14

## EAR PLUG

DESCRIPTION	
<b>MATERIAL</b>	POLYETHYLENE (PE-LD)
<b>COLOR</b>	YELLOW
<b>NOTE</b>	

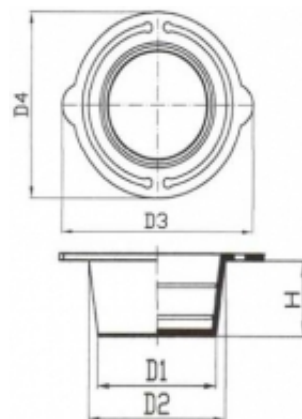

CODE	D1	D2	D3	D4	H	GAS	HOLE RANGE
STCF5	5	7	20,3	17,3	9,5		5 - 7
STCF6	6	8	21,1	18,2	9,5		6 - 8
STCF7	7	9,5	23,3	20,3	9,5		7 - 9,5
STCF8	8	10	23,2	20,3	9,5	1/8"	8 - 10
STCF9,5	9,5	11,5	24,8	21,9	9,5		9,5 - 11,5
STCF10,5	10,5	12,5	26,5	22,6	9,5	1/4"	10,5 - 12,5
STCF11,5	11,5	13,5	27,5	23,7	9,5		11,5 - 13,5
STCF12,5	12,5	14,5	28,4	24,5	10		12,5 - 14,5
STCF13,5	13,5	15,5	29,5	25,5	10		13,5 - 15,5
STCF14,2	14,2	16,2	30,3	26,3	10	3/8"	14,2 - 16,2
STCF14,5	14,5	17	31	27	10		14,5 - 17
STCF15,5	15,5	18	32	28,3	10		15,5 - 18
STCF17,5	17,5	19,5	34	30	10		17,5 - 19,5
STCF18	18	20	34	30	10	1/2"	18 - 20
STCF19	19	21,5	35,7	32	11		19 - 21,5
STCF21	21	23,5	38,7	34,7	11		21 - 23,5
STCF22,5	22,5	25,5	40	36	12	3/4"	22,5 - 25,5
STCF25	25	28	42,2	38,5	12		25 - 28
STCF29	29	31,5	47	41,8	12		29 - 31,5
STCF29,5	29,5	31,8	47,6	42,5	12	1"	29,5 - 31,8

**PIPES, FLANGES, VALVES AND PROTECTION CAPS**

DESCRIPTION	
<b>MATERIAL</b>	POLYTHENE
<b>COLOR</b>	NATURAL
<b>NOTE</b>	

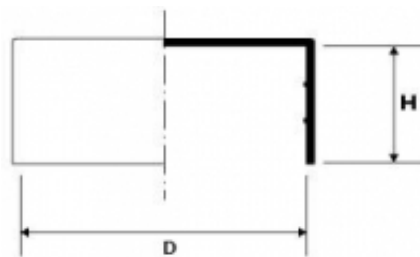

CODE	D	H	GAS
TXT004	4	18,8	-
TXT005	5	18,8	-
TXT006	6	18,5	-
TXT006,35	6,35	18,5	-
TXT007	7	18,5	-
TXT008	8	19,8	-
TXT009,6	9,6	18,8	1/8"
TXT010	10	18,8	1/8"
TXT011	11	19,7	-
TXT011,5	11,5	19,7	-
TXT012	12	19,6	-
TXT012,7	12,7	19,9	-
TXT013	13	19,9	1/4"
TXT013,7	13,7	19,9	1/4"
TXT014	14	16,7	-
TXT015	15	20,1	-
TXT015,5	15,5	16,7	-
TXT016	16	16,7	-
TXT017,2	17,2	18	3/8"
TXT018	18	18	-
TXT018,5	18,5	18	-
TXT019	19	18	-
TXT020	20	21,3	-
TXT021,3	21,3	20,8	1/2"
TXT022	22	20,8	-
TXT023,2	23,2	21	-
TXT024	24	21	-
TXT025,4	25,4	21	-
TXT026	26	25	-
TXT026,9	26,9	25	3/4"
TXT028,5	28,5	25	-
TXT029	29	25	-
TXT030	30	25,6	-

CODE	D	H	GAS
TXT031,8	31,8	19,2	-
TXT033,7	33,7	19,2	1"
TXT035	35	25,6	-
TXT036,5	36,5	20,6	-
TXT038	38	20,6	-
TXT040	40	25,6	-
TXT041,3	41,3	20	-
TXT042,4	42,4	25,3	1.1/4"
TXT044,5	44,5	21,2	-
TXT045,4	45,4	21,2	-
TXT047,5	47,5	25	-
TXT048,3	48,3	30	1.1/2"
TXT051	51	29,5	-
TXT052	52	30,8	-
TXT052,8	52,8	30,8	-
TXT054	54	30	1.3/4"
TXT055	55	30	-
TXT057	57	30	-
TXT060,3	60,3	27,8	2"
TXT063,5	63,5	28	-
TXT065	65	28	-
TXT067	67	35,4	-
TXT070	70	35,4	-
TXT073	73	29	2.1/2"
TXT075	75	29	-
TXT076,1	76	29	2.1/2"
TXT077	77	30,5	-
TXT078	78	30,5	-
TXT080	80	30,5	-
TXT082	82	30,5	-
TXT083	83	30,5	-
TXT085	85	30,5	-
TXT088,9	88,9	35,6	3"
TXT090	90	30	-
TXT092,4	92,4	30	-
TXT095	95	39	-
TXT098	98	31	-
TXT100	100	31	-
TXT101,6	101,6	29,5	3.1/2"
TXT103	103	41	-
TXT106	106	41	-
TXT108	108	38,6	-
TXT110	110	38,6	-
TXT114,3	114,3	40,3	4"
TXT117,5	117,5	41,5	-
TXT121	121	39	-
TXT125	125	39	-
TXT127	127	36,2	-
TXT130	130	40	-
TXT133	133	40	-
TXT136	136	40	-
TXT138	138	32,5	-
TXT139,7	139,7	40	5"
TXT141,3	141,3	40	5"
TXT146	146	40	-
TXT148	148	39	-
TXT152,4	152,4	39	-

CODE	D	H	GAS
TXT156	156	40	-
TXT159	159	49,5	-
TXT160	160	49,5	-
TXT165	165	40	-
TXT168,3	168,3	39,6	6"
TXT170	170	45	-
TXT176	176	42	-
TXT177,8	177,8	42	-
TXT180	180	50,5	-
TXT185	185	40	-
TXT190	190	42	-
TXT193,7	193,7	42	-
TXT200	200	50,7	-
TXT210	210	40	-
TXT219,1	219,1	44,6	8"
TXT225	225	40,3	-
TXT232	232	40	-
TXT242	242	50	-
TXT245	245	50	-
TXT250	250	40,3	-
TXT267	267	43	-
TXT273	273	51,6	10"
TXT315	315	50	-
TXT323,9	323,9	49,5	12"
TXT355,6	355,6	56,8	14"
TXT366	366	54	-
TXT400	400	65	-
TXT406,4	406,4	63,3	16"
TXT419	419	58	-
TXT450	450	65	-
TXT457,2	457,2	64,5	18"
TXT508	508	67,5	20"
TXT558,8	558,8	76	22"
TXT609,6	609,6	63,8	24"
TXT660,4	660,4	105	26"
TXT711,2	711,2	120	28"
TXT762	762	120	30"
TXT812,8	812,8	120	32"
TXT863,6	863,6	170	-
TXT914,4	914,4	150	36"
TXT965,2	965,2	120	-
TXT1016	1016	180	40"
TXT1066,8	1066,8	185	42"
TXT1117,6	1117,6	185	44"
TXT1219,2	1219,2	200	48"
TXT1320,8	1320,8	150	52"
TXT1422,4	1422,4	215	56"
TXT1524	1524	220	60"
TXT1625,6	1625,6	230	64"

## THREADED PLUGS FOR ELECTRICAL PANELS

DESCRIPTION	
<b>MATERIAL</b>	NYLON 6.6
<b>COLOR</b>	GREY
<b>NOTE</b>	

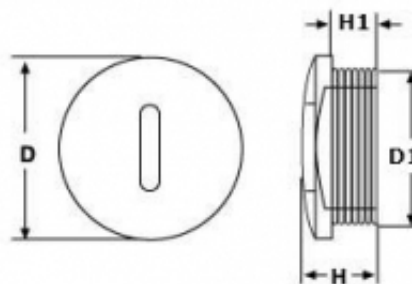

CODE	D	D1	H	H1
TFE-PG7	14,8	PG - 7	10	6
TFE-PG9	18,7	PG - 9	10,4	6
TFE-PG11	21,7	PG - 11	10,4	6
TFE-PG13,5	23,7	PG - 13,5	10,3	6
TFE-PG16	27	PG - 16	10,3	6
TFE-PG21	32,8	PG - 21	12,5	7,8
TFE-PG29	44,1	PG - 29	13,3	7,8
TFE-PG36	52,6	PG - 36	13,7	7,7
TFE-PG42	59,5	PG - 42	16,3	9,6
TFE-PG48	64,2	PG - 48	18	11,8
TFE-12	15	M 12 x 1,5	10	6
TFE-16	20	M 16 x 1,5	10,5	6
TFE-20	24	M 20 x 1,5	10,5	6
TFE-25	29,7	M 25 x 1,5	12,8	7,8
TFE-32	36,6	M 32 x 1,5	13,3	7,8
TFE-40	45,8	M 40 x 1,5	13,4	7,8
TFE-50	55,5	M 50 x 1,5	16,2	9,8
TFE-63	69,3	M 63 x 1,5	17,5	11,8

## SNAP-FIT

DESCRIPTION	
<b>MATERIAL</b>	POLYTHENE
<b>COLOR</b>	RED
<b>NOTE</b>	GAS column also valid for type thread UNF

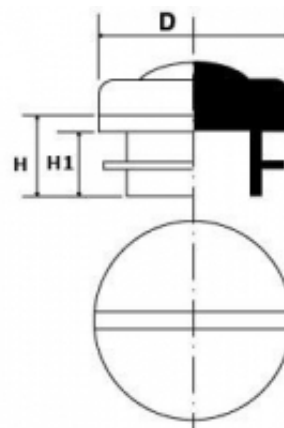

CODE	D	H	H1	THREAD	GAS	UNF
SF1/8	9,8	6	4	M10	1/8"	7/16"
SF1/4	13,1	7	5	M12 - M13 - M14	1/4"	1/2"
SF3/8	16,5	7	5	M16	3/8"	5/8"
SF1/2M18	18,3	9	7	M18	1/2"	3/4"
SF1/2M20	21,3	9	7	M20	1/2"	
SF5/8	22,4	9	7	M22	5/8"	7/8"
SFM24	23,5	9	7	M24		
SF3/4	25,5	9	7	M25 - M26	3/4"	1.1/16"
SF7/8	27,9	9	7	M28	7/8"	1.1/8"
SF1	32	9	7	M32	1"	1.5/16"
SF1.1/8	35,7	9	7	M36	1.1/8"	1.1/2", 1.3/8"
SF1.1/4	41,5	9	7	M40 - M42	1.1/4"	1.5/8"

## QUICK-FIT THREADED PLUG

DESCRIPTION	
<b>MATERIAL</b>	POLYTHENE (LDPE)
<b>COLOR</b>	RED
<b>NOTE</b>	GAS column also valid for type thread BSP UNF column also valid for type thread JIC

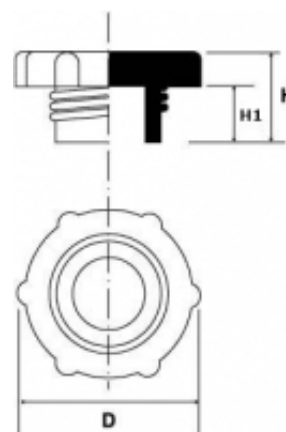

CODE	D	H	H1	THREAD	GAS	UNF	PITCH
QF7/16U	18,5	9	5,9			7/16"	20
QF1/4	20,5	9,2	6		1/4"		19
QF1/2U	20,6	9,1	5,9			1/2"	20
QF9/16U	21,4	9	5,9			9/16"	18
QF14	21,5	12,5	8	M14			1,5
QF16	23,6	12,5	8	M16			1,5
QF3/8	24,1	9,6	6,2		3/8"		19
QF20	26	13	8	M20			1,5
QF3/4U	26,7	9,3	5,9			3/4"	16
QF7/8U	29,8	9,2	6,2			7/8"	14
QF5/8	30,2	9,2	6		5/8"		14
QF1/2	30,4	9,2	6,1		1/2"		14
QF3/4B	33,2	12,5	6,8		3/4"		14
QF1,1/16U	33,9	9	5,9			1.1/16"	12
QF3/4	34	9,1	6,1		3/4"	3/4"	14
QF30	39,9	14,6	9,8	M30			2
QF1	40,2	9	5,7		1"		11
QF1,5/16U	40,3	9,4	6			1.5/16"	12
QF36	45,6	21,5	10,5	M36			2
QF1,1/4	49,5	18,7	12,9		1.1/4"		11
QF45	57,8	18,5	12,7	M45			2
QF42	64,7	21,2	15,5	M42			2
QF52	65,9	21,3	15,4	M52			2



## SOFT END CAPS

DESCRIPTION	
<b>MATERIAL</b>	PVC
<b>COLOR</b>	BLACK
<b>NOTE</b>	

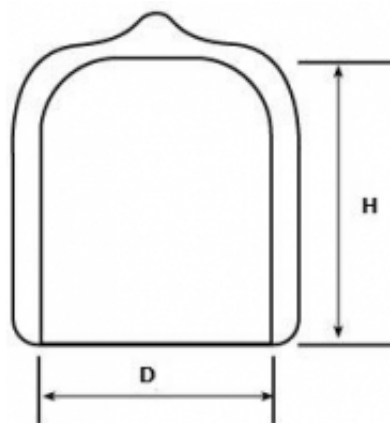

CODE	D	H
PM2X13	2	13
PM2.4X13	2,4	13
PM2.8X13	2,8	13
PM3.2X13	3,2	13
PM3.6X13	3,6	13
PM3.6X19	3,6	19
PM3.6X25	3,6	25
PM3.9X13	3,9	13
PM3.9X19	3,9	19
PM3.9X25	3,9	25
PM4.4X13	4,4	13
PM4.4X19	4,4	19
PM4.4X25	4,4	25
PM4.8X13	4,8	13
PM4.8X19	4,8	19
PM4.8X25	4,8	25
PM5.2X13	5,2	13
PM5.2X19	5,2	19
PM5.2X25	5,2	25
PM5.5X13	5,5	13
PM5.5X19	5,5	19
PM5.5X25	5,5	25
PM5.9X13	5,9	13
PM5.9X19	5,9	19
PM5.9X25	5,9	25
PM6.4X13	6,4	13
PM6.4X19	6,4	19
PM6.4X25	6,4	25
PM7X13	7	13
PM7X19	7	19

CODE	D	H
PM7X25	7	25
PM7.7X13	7,7	13
PM7.7X19	7,7	19
PM7.7X25	7,7	25
PM7.9X13	7,9	13
PM7.9X19	7,9	19
PM7.9X25	7,9	25
PM8.3X13	8,3	13
PM8.3X19	8,3	19
PM8.3X25	8,3	25
PM8.7X13	8,7	13
PM8.7X19	8,7	19
PM8.7X25	8,7	25
PM9.5X13	9,5	13
PM9.5X19	9,5	19
PM9.5X25	9,5	25
PM10.3X13	10,3	13
PM10.3X19	10,3	19
PM10.3X25	10,3	25
PM11.1X13	11,1	13
PM11.1X19	11,1	19
PM11.1X25	11,1	25
PM11.9X13	11,9	13
PM11.9X19	11,9	19
PM11.9X25	11,9	25
PM12.7X13	12,7	13
PM12.7X19	12,7	19
PM12.7X25	12,7	25
PM12.7X110	12,7	110
PM13.5X13	13,5	13
PM13.5X19	13,5	19
PM13.5X25	13,5	25
PM13.8X13	13,8	13
PM13.8X19	13,8	19
PM13.8X25	13,8	25
PM14.3X13	14,3	13
PM14.3X19	14,3	19
PM14.3X25	14,3	25
PM15.2X13	15,2	13
PM15.2X19	15,2	19
PM15.2X25	15,2	25
PM15.9X13	15,9	13
PM15.9X19	15,9	19
PM15.9X25	15,9	25
PM15.9X110	15,9	110
PM17.4X13	17,4	13
PM17.4X19	17,4	19
PM17.4X25	17,4	25
PM19.1X13	19,1	13
PM19.1X19	19,1	19
PM19.1X25	19,1	25
PM19.1X110	19,1	110
PM19.9X13	19,9	13
PM19.9X19	19,9	19
PM19.9X25	19,9	25
PM20.6X13	20,6	13
PM20.6X25	20,6	25

CODE	D	H
PM20.6X38	20,6	38
PM21.4X13	21,4	13
PM21.4X25	21,4	25
PM21.4X38	21,4	38
PM22.2X13	22,2	13
PM22.2X25	22,2	25
PM22.2X38	22,2	38
PM22.2X110	22,2	110
PM23.8X13	23,8	13
PM23.8X25	23,8	25
PM23.8X38	23,8	38
PM24.6X13	24,6	13
PM24.6X25	24,6	25
PM24.6X38	24,6	38
PM25.4X13	25,4	13
PM25.4X25	25,4	25
PM25.4X38	25,4	38
PM25.4X110	25,4	110
PM26.3X13	26,3	13
PM26.3X25	26,3	25
PM26.3X38	26,3	38
PM26.9X13	26,9	13
PM26.9X25	26,9	25
PM26.9X38	26,9	38
PM28.6X25	28,6	25
PM28.6X38	28,6	38
PM28.6X50	28,6	50
PM30.2X25	30,2	25
PM30.2X38	30,2	38
PM30.2X50	30,2	50
PM31.8X25	31,8	25
PM31.8X38	31,8	38
PM31.8X50	31,8	50
PM34.9X25	34,9	25
PM34.9X38	34,9	38
PM34.9X50	34,9	50
PM38.1X25	38,1	25
PM38.1X38	38,1	38
PM38.1X50	38,1	50
PM41.3X25	41,3	25
PM41.3X38	41,3	38
PM41.3X50	41,3	50
PM44.5X25	44,5	25
PM44.5X38	44,5	38
PM44.5X50	44,5	50
PM47.6X25	47,6	25
PM47.6X38	47,6	38
PM47.6X50	47,6	50
PM50.8X25	50,8	25
PM50.8X38	50,8	38
PM50.8X50	50,8	50
PM53.9X38	53,9	38
PM53.9X50	53,9	50
PM57.2X38	57,2	38
PM57.2X50	57,2	50
PM60.3X38	60,3	38
PM60.3X50	60,3	50

CODE	D	H
PM63.5X38	63,5	38
PM63.5X50	63,5	50
PM66.7X38	66,7	38
PM66.7X50	66,7	50
PM69.8X38	69,8	38
PM69.8X50	69,8	50
PM76.2X38	76,2	38
PM76.2X50	76,2	50

## THREADED CAPS

DESCRIPTION	
<b>MATERIAL</b>	POLYTHENE
<b>COLOR</b>	RED
<b>NOTE</b>	GAS column also valid for type thread UNF

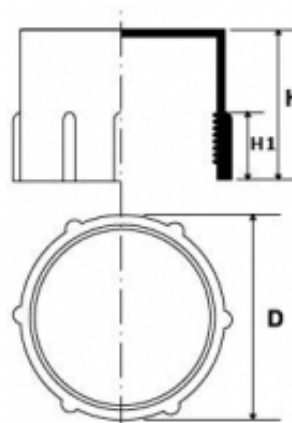

CODE	D	H	H1	THREAD	GAS	UNF	PITCH
CF1/8	11,8	12	6,5		1/8"		28
CF1	36	19	14,5		1"		11
CF1/4	14,8	11	8		0.1/4"		19
CF1.1/4	44,4	19,8	13		1.1/4"		11
CF3/8	18,7	11,3	7,4		3/8"		19
CF1.1/2	50,3	20,5	14		1.1/2"		11
CF2	61,9	21	15		2"		11
CF1/2	23,2	13,5	7		1/2"		14
CF2.1/4	71,5	25	17,5		2.1/4"		11
CF5/8	25,4	15,7	10		5/8"		14
CF2.1/2	77,9	27,6	19		2.1/2"		11
CF3/4	29,4	17,7	11,2		3/4"		14
CF7/8	32,4	19,5	12,5		7/8"		14
CF8X1	9,9	10	7	M8			1
CF10X1	11,9	10	7,5	M10			1
CF12X1	13,8	12	9,5	M12			1
CF12X1,5	14	12	9,5	M12			1,5
CF14X1,5	15,9	12	9,5	M14			1,5
CF14X1,5B	16	20,6	9,2	M14			1,5
CF16X1,5	17,9	12	9,5	M16			1,5
CF16X1,5B	18	21	9	M16			1,5
CF18X1,5	19,7	14	11,5	M18			1,5
CF20X1,5	21,9	14	9,5	M20			1,5
CF22X1,5	24,3	13,8	11,5	M22			1,5
CF22X1,5B	24,4	24,5	17,5	M22			1,5
CF24X1,5	26,2	14	11,5	M24			1,5
CF25X1,5	27,2	14	11,5	M25			1,5
CF26X1,5	28,3	14	11,5	M26			1,5
CF28X1,5	32	14	12,4	M28			1,5
CF30X2	34	14	11,5	M30			2

CODE	D	H	H1	THREAD	GAS	UNF	PITCH
CF36X2	38,8	16	13,5	M36			2
CF42X2	44,5	16	13,5	M42			2
CF52X2	54,7	16	13,5	M52			2
CF3/8U	11	8,3	4			3/8"	24
CF7/16X24U	13,3	13,7	7,8			7/16"	24
CF7/16X20U	13,3	12,9	8			7/16"	20
CF1/2U	14,5	13,5	9,5			1/2"	20
CF9/16X18U	16,5	13,5	9,5			9/16"	18
CF5/8U	18,2	15,6	7,5			5/8"	18
CF3/4U	21,7	13,8	9,5			3/4"	16
CF13/16X16U	23,3	15,3	9,3			13/16"	16
CF7/8X14U	24,9	20,2	14,4			7/8"	14
CF7/8X18U	25,3	20	14			7/8"	18
CF1U	27,6	17,2	12			1"	14
CF1.1/16U	29,4	19	11			1.1/16"	12
CF1.3/16U	32,7	19,1	13			1.3/16"	12
CF1.5/16U	36,4	22,2	14,5			1.5/16"	12
CF1.3/8U	37,4	24,5	10,5			1.3/8"	12
CF1.7/16U	38,9	21,7	15,2			1.7/16"	12
CF1.5/8U	44,8	22	14			1.5/8"	12
CF1.7/8U	50,3	25	15			1.7/8"	12

## QUICK THREADED CAPS

DESCRIPTION	
<b>MATERIAL</b>	POLYTHENE (LDPE)
<b>COLOR</b>	RED
<b>NOTE</b>	

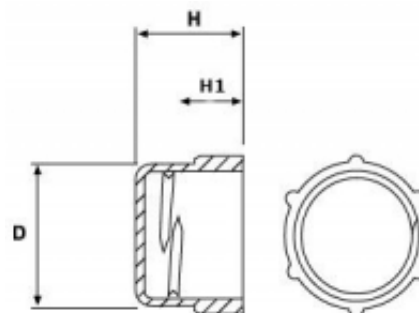

CODE	D	H	H1	THREAD	PITCH
CFV8X1,0	10	10	6	M8	1
CFV10X1,0	12	10	6	M10	1
CFV12X1,5	14	12	7,5	M12	1,5
CFV14X1,5	16	12	7,5	M14	1,5
CFV14X1,5B	16	21	8,5	M14	1,5
CFV16X1,5	18	12	7,5	M16	1,5
CFV16X1,5B	18	21	6,5	M16	1,5
CFV18X1,5	20	14	9,5	M18	1,5
CFV20X1,5	22	14	9,5	M20	1,5
CFV22X1,5	24,5	14	9,5	M22	1,5
CFV24X1,5	26,5	14	9,5	M24	1,5
CFV26X1,5	28,5	14	9,5	M26	1,5
CFV28X1,5	32	14	9,5	M28	1,5
CFV30X2	34	14	9	M30	2

## THREADED CAPS WITH SEAL

DESCRIPTION	
<b>MATERIAL</b>	POLYETHYLENE (PE-LD) - ASSEMBLED NEOPRENE SEAL
<b>COLOR</b>	RED
<b>NOTE</b>	

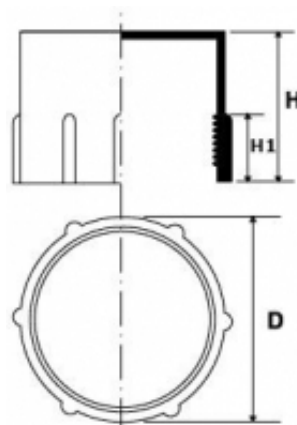

CODE	D	H	H1	THREAD	GAS	UNF
CFG1/8	11,8	12	6,5		1/8 x 28	
CFG1/4	14,8	11	8		1/4 x 19	
CFG3/8	18,7	11,3	7,4		3/8 x 19	
CFG1/2	23,2	13,5	7		1/2 x 14	
CFG5/8	25,4	15,7	10		5/8 x 14	
CFG3/4	29,4	17,7	11,2		3/4 x 14	
CFG7/8	32,4	19,5	12,5		7/8 x 14	
CFG1	36	19	14,5		1 x 11	
CFG1.1/4	44,4	19,8	13		1.1/4 x 11	
CFG1.1/2	50,3	20,5	14		1.1/2 x 11	
CFG2	61,9	21	15		2 x 11	
CFG2.1/4	71,5	25	17,5		2.1/4 x 11	
CFG2.1/2	77,9	27,6			2.1/2 x 11	
CFG8X1	9,9	10	7	M8 x 1		
CFG10X1	11,9	10	7,5	M10 x 1		
CFG12X1	13,8	12	9,5	M12 x 1		
CFG12X1.5	14	12	9,5	M12 x 1.5		
CFG14X1.5	15,9	12	9,5	M14 x 1.5		
CFG14X1.5B	16	20,6	9,2	M14 x 1.5		
CFG16X1.5	17,9	12	9,5	M16 x 1.5		
CFG16X1.5B	18	21	9	M16 x 1.5		
CFG18X1.5	19,7	14	11,5	M18 x 1.5		
CFG20X1.5	21,9	14	9,5	M20 x 1.5		
CFG22X1.5	24,3	13,8	11,5	M22 x 1.5		
CFG22X1.5B	24,4	24,5	17,5	M22 x 1.5		
CFG24X1.5	26,2	14	11,5	M24 x 1.5		
CFG25X1.5	27,2	14	11,5	M25 x 1.5		
CFG26X1.5	28,3	14	11,5	M26 x 1.5		
CFG28X1.5	32	14	12,4	M28 x 1.5		
CFG30X2	34	14	11,5	M30 x 2		



CODE	D	H	H1	THREAD	GAS	UNF
CFG36X2	38,8	16	13,5	M36 x 2		
CFG42X2	44,5	16	13,5	M42 x 2		
CFG52X2	54,7	16	13,5	M52 x 2		
CFG3/8U	11	8,3	4			3/8" x 24
CFG7/16X24U	13,3	13,7	7,8			7/16" x 24
CFG7/16X20U	13,3	12,9	8			7/16" x 20
CFG1/2U	14,5	13,5	9,5			1/2" x 20
CFG9/16X18U	16,5	13,5	9,5			9/16" x 18
CFG5/8U	18,2	15,6	7,5			5/8" x 18
CFG3/4U	21,7	13,8	9,5			3/4" x 16
CFG13/16X16U	23,3	15,3	9,3			13/16" x 16
CFG7/8X14U	24,9	20,2	14,4			7/8" x 14
CFG7/8X18U	25,3	20	14			7/8" x 18
CFG1U	27,6	17,2	12			1" x 14
CFG1.1/16U	29,4	19	11			1.1/16" x 12
CFG1.3/16U	32,7	19,1	13			1.3/16" x 12
CFG1.5/16U	36,4	22,2	14,5			1.5/16" x 12
CFG1.3/8U	37,4	24,5	10,5			1.3/8" x 12
CFG1.7/16U	38,9	21,7	15,2			1.7/16" x 12
CFG1.5/8U	44,8	22	14			1.5/8" x 12
CFG1.7/8U	50,3	25	15			1.7/8" x 12

## THREADED SEALING CAPS

DESCRIPTION	
<b>MATERIAL</b>	HDPE
<b>COLOR</b>	Yellow
<b>NOTE</b>	UNF column also valid for type thread BSP ALMOST OUT OF STOCK, SOON TO BE REPLACED BY CFG SERIES.

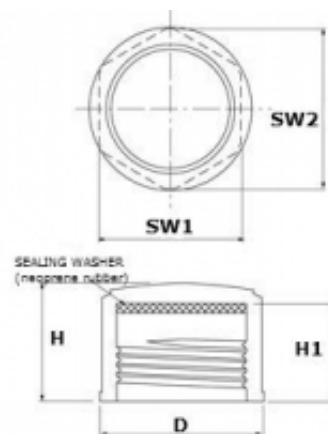

CODE	D	H	H1	THREAD	UNF	SW1	SW2	BSP	PITCH
CFT8X1	12	13	11	M8		10	11		1
CFT10X1	14,2	13	11	M10		12	13,2		1
CFT12X1	16,5	13	11	M12		14	15,4		1
CFT12X1,5	16,5	15	13	M12		14	15,4		1,5
CFT14X1,5	18,5	15	13	M14		16	17,5		1,5
CFT16X1,5	21	15	13	M16		18	19,7		1,5
CFT18X1,5	23	15	13	M18		20	21,9		1,5
CFT20X1,5	25	15	13	M20		22	24,1		1,5
CFT22X1,5	27,5	15	13	M22		24	26,3		1,5
CFT24X1,5	30	15	13	M24		26	28,5		1,5
CFT25X1,5	31	15	13	M25		27	29,6		1,5
CFT26X1,5	32	15	13	M26		28	30,7		1,5
CFT28X1,5	34	15	13	M28		30	32,9		1,5
CFT30X1,5	36,5	15	13	M30		32	35,1		1,5
CFT30X2	36,5	17	15	M30		32	35,1		2
CFT36X1,5	44,5	16	14	M36		39	42,8		1,5
CFT36X2	44,5	18	16	M36		39	42,8		2
CFT42X2	51	18,5	16	M42		45	49,4		2
CFT45X1,5	54,5	16,5	14	M42		48	52,6		1,5
CFT45X2	54,5	18,5	16	M45		48	52,6		2
CFT52X2	62	18,5	16	M52		55	60,3		2
CFT1/4U	10	13,5	11,5		1/4"	8	8,8		28
CFT3/8U	13	14,5	12,5		3/8"	11	12,1		24
CFT7/16X24 U	15,5	14,5	12,5		7/16"	13	14,3		24
CFT7/16X20 U	15,5	15	13		7/16"	13	14,3		20
CFT1/2U	17,5	15	13		1/4"	15	16,5		28
CFT9/16U	18,5	15,5	13,5		9/16"	16	17,5		18

CODE	D	H	H1	THREAD	UNF	SW1	SW2	BSP	PITCH
CFT5/8U	21	15,5	13,5		5/8"	18	19,7		18
CFT3/4U	24	16,5	14,5		3/4"	21	23		16
CFT13/16U	26,5	16,5	14,5		13/16"	23	25,2		16
CFT7/8X18U	27,5	15,5	13,5		7/8"	24	26,3		18
CFT7/8X14U	27,5	17,5	15,5		7/8"	24	26,3		14
CFT1U	31	17,5	15,5		1"	27	29,6		14
CFT1,1/16U	34,5	18,5	16,5		1.1/16"	30	32,9		12
CFT1,3/16U	36,5	18,5	16,5		1.3/16"	32	35,1		12
CFT1,5/16U	41	18,5	16,5		1.5/16"	36	39,5		12
CFT1,3/8U	43	18,5	16,5		1 3/8"	38	41,7		12
CFT1.7/16U	45,5	18,5	16,5		1 7/16"	40	43,9		12
CFT1.5/8U	51	19	16,5		1.5/8"	45	49,4		12
CFT1,3/4U	54,5	17	14,5		1 3/4"	48	52,6		16
CFT1,7/8U	59	19	16,5		1.7/8"	52	57		12
CFT1/8	14	13	11			12	13,2	1/8"	28
CFT1/4	17,5	15	13			15	16,5	1/4"	19
CFT3/8	22	15	13			19	20,8	3/8"	19
CFT1/2	25	17	15			22	24,1	1/2"	14
CFT5/8	29	17	15			25	27,4	5/8"	14
CFT3/4	32	17	15			28	30,7	3/4"	14
CFT7/8	36	17	15			32	35,1	7/8"	14
CFT1	41	19	17			36	39,5	1"	11
CFT1.1/4	51	19	17			45	49,4	1. 1/4"	11
CFT1.1/2	56	19,5	17			50	54,8	1. 1/2"	11
CFT2	71	19,5	17			63	69,1	2"	11
CFT2,1/4	80	19,5	17			70	76,8	2. 1/4"	11
CFT2.1/2	90	19,5	17			80	87,7	2. 1/2"	11

## HEXAGONAL CAPS

DESCRIPTION	
<b>MATERIAL</b>	LDPE
<b>COLOR</b>	NATURAL
<b>NOTE</b>	

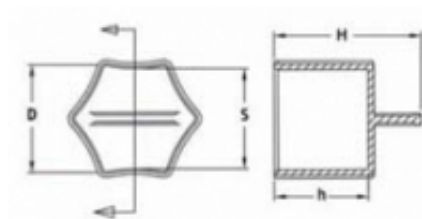

CODE	D	H	H1	S
TES11	11	28	16	10,7
TES14	14	30	18	13,7
TES16	16	32	20	15,7
TES17	17	32	20	16,7
TES19	19	39	25	18,7
TES22	22	39	25	21,6
TES24	24	42	28	23,6
TES25	25	42	28	24,6
TES27	27	42	28	26,6
TES29	29	44	30	28,6
TES30	30	44	30	29,6
TES32	32	44	30	31,6
TES36	36	44	30	35,5
TES38	38	45	31	37,5
TES41	41	45	31	40,5
TES46	46	46	32	45,5
TES50	50	46	32	49,5

## PULL-TAB CAPS

DESCRIPTION	
<b>MATERIAL</b>	EVA (Ethylene Vinyl Acetate)
<b>COLOR</b>	Yellow
<b>NOTE</b>	Large pull-tab allows easy removal Internal lip prevents ingress of dirt Material provides good tensile strength, toughness and increased flexibility Ideal for capping hydraulic hoses and fittings

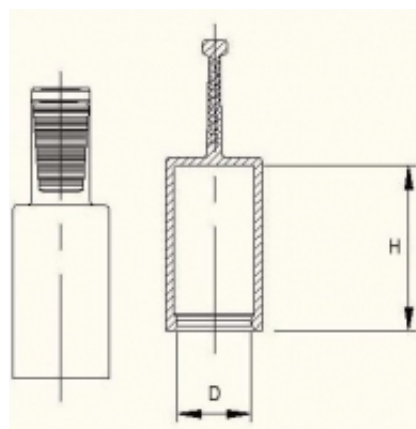

CODE	D	H
CTI4X21	4	21
CTI5X20	5	20
CTI6X20	6	20
CTI8X20	8	20
CTI9X20	9	20
CTI10X20	10	20
CTI11X20	11	20
CTI12X20	12	20
CTI13X20	13	20
CTI14X20	14	20
CTI15X20	15	20
CTI16X20	16	20
CTI18X20	18	20
CTI20X20	20	20
CTI20X30	20	30
CTI24X20	24	20

## PVC PULL TAB

DESCRIPTION	
<b>MATERIAL</b>	PVC
<b>COLOR</b>	BLACK
<b>NOTE</b>	GAS column also valid for type thread BSP

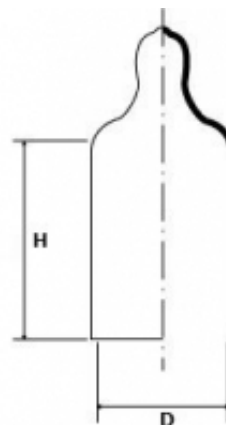

CODE	D	H	THREAD	GAS	UNF
CAPM3,6X13	3,6	13	M4		
CAPM4,8X13	4,8	13	M4		
CAPM5,3X13	5,3	13	M6		7/32"
CAPM6,1X13	6,1	13			1/4"
CAPM7,5X13	7,5	13			-
CAPM7,5X25	7,5	25			-
CAPM7,7X13	7,7	13	M8		5/16"
CAPM7,7X25	7,7	25			-
CAPM8,7X13	8,7	13			
CAPM8,7X25	8,7	25			
CAPM9,3X13	9,3	13	M10	1/8"	3/8"
CAPM9,3X25	9,3	25			-
CAPM9,7X13	9,7	13			-
CAPM9,7X25	9,7	25			-
CAPM10,8X13	10,8	13			7/16"
CAPM10,8X25	10,8	25			-
CAPM11,1X13	11,1	13			-
CAPM11,1X25	11,1	25			-
CAPM11,9X13	11,9	13	M12		1/2"
CAPM11,9X25	11,9	25			-
CAPM12,4X13	12,4	13		1/4"	1/2"
CAPM12,4X25	12,4	25		1/4"	1/2"
CAPM13,2X13	13,2	13	M14		17/32"
CAPM13,2X25	13,2	25			-
CAPM14,3X25	14,3	25	M15		9/16"
CAPM15,3X13	15,3	13	M16		-
CAPM15,3X25	15,3	25			-
CAPM15,9X25	15,9	25		3/8"	5/8"
CAPM16,3X13	16,3	13	M18		11/16"
CAPM16,3X25	16,3	25			-

CODE	D	H	THREAD	GAS	UNF
CAPM17,4X13	17,4	13	M18		
CAPM17,4X25	17,4	25	M18		
CAPM18,8X13	18,8	13	M20		3/4"
CAPM18,8X25	18,8	25			-
CAPM20X13	20	13			-
CAPM20X25	20	25			-
CAPM20,6X13	20,6	13	M22	1/2"	13/16"
CAPM20,6X25	20,6	25			-
CAPM22X25	22	25		5/8"	7/8"
CAPM23,8X13	23,8	13			-
CAPM23,8X25	23,8	25			-
CAPM24,6X13	24,6	13	M25		-
CAPM24,6X25	24,6	25	M25		-
CAPM25,1X13	25,1	13	M26		1"
CAPM25,1X25	25,1	25	M26		1"
CAPM26,9X25	26,9	25			-
CAPM28,6X25	28,6	25	M30	7/8"	1.1/8"
CAPM28,6X38	28,6	38	M30	7/8"	1.1/8"
CAPM31,2X38	31,2	38	M32	1"	1.1/4"
CAPM34,9X25	34,9	25	M35	-	1.3/8"
CAPM34,9X38	34,9	38	M35	-	1.3/8"
CAPM38,1X38	38,1	38	M39	-	1.1/2"
CAPM38,1X50	38,1	50	M39	-	1.1/2"
CAPM40,8X38	40,8	38			1.5/8"
CAPM41,3X38	41,3	38	M42	1.1/4"	-
CAPM41,3X50	41,3	50	M42	1.1/4"	-
CAPM44,5X38	44,5	38	M45	1.3/8"	-
CAPM44,5X50	44,5	50	M45	1.3/8"	-
CAPM50,8X50	50,8	50			2"

## PVC CAP

DESCRIPTION	
<b>MATERIAL</b>	PVC
<b>COLOR</b>	BLACK
<b>NOTE</b>	

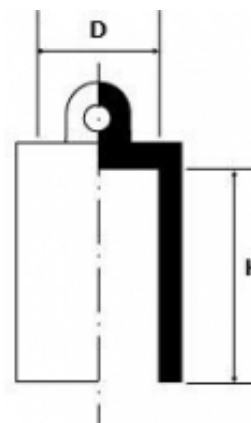

CODE	D	H
CAPPVC5X23,5	5	23,5
CAPPVC6X25	6	25
CAPPVC7X24	7	24
CAPPVC8X24,5	8	24,5
CAPPVC9X25	9	25
CAPPVC10X29,5	10	29,5
CAPPVC11X29	11	29
CAPPVC12X29	12	29
CAPPVC13X29	13	29
CAPPVC14X28,5	14	28,5
CAPPVC15X29,5	15	29,5
CAPPVC16X28	16	28
CAPPVC17X29,5	17	29,5
CAPPVC18X28,5	18	28,5
CAPPVC19X29,5	19	29,5
CAPPVC20X28,5	20	28,5
CAPPVC21X34,5	21	34,5
CAPPVC22X34	22	34
CAPPVC23X34,5	23	34,5
CAPPVC24X34	24	34
CAPPVC25X34,5	25	34,5
CAPPVC26X34,5	26	34,5
CAPPVC27X33,5	27	33,5
CAPPVC28X33,5	28	33,5
CAPPVC29X35	29	35
CAPPVC30X34,5	30	34,5



## QUICK-FIT QUICK-RELEASE CAP

DESCRIPTION	
<b>MATERIAL</b>	POLYTHENE
<b>COLOR</b>	YELLOW OR BLUE
<b>NOTE</b>	

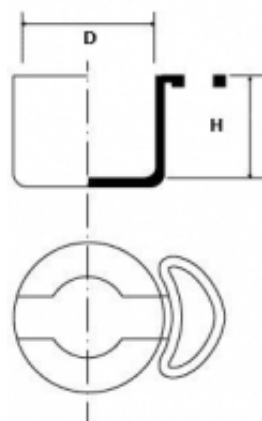

CODE	D	H	THREAD	GAS	PITCH
TLS3/8U	9,2	11,1			
TLS7/16U	11	11,7			
TLS12	12	12	M12		M12
TLS 1/2U	12,4	11,7			
TLS1/4	13	11		1/4"	19
TLS14	14	14,1	M14		
TLS9/16U	14	12,1			
TLS3/8	16	12		3/8"	19
TLS16	16	16,5	M16		
TLS18	18	18	M18		
TLS20	20	20	M20		
TLS1/2	21,2	15		1/2"	14
TLS22	22	22	M22		
TLS5/8	23	18,5		5/8"	14
TLS3/4	26,3	23,8		3/4"	14
TLS7/8	29,5	25		7/8"	14
TLS1	34	18		1"	11

## FINNED CAPS

DESCRIPTION	
<b>MATERIAL</b>	POLYTHENE (LDPE)
<b>COLOR</b>	NATURAL
<b>NOTE</b>	

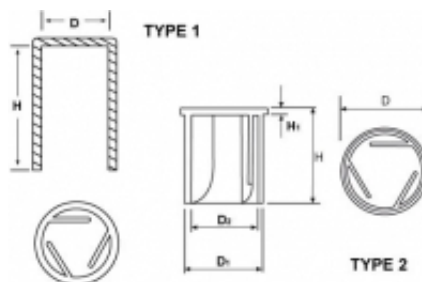

CODE	D	D1	D2	H	H1	RANGE D. EST.
CA6,5	10	-	-	31,5	-	6,5 - 8
CA8	11	-	-	20,5	-	8 - 9
CA9	12	-	-	20,5	-	9 - 10
CA2-6,5	14	12	10	22	1,5	6,5 - 8
CA2-8	15	13	11	22	1,5	8 - 9
CA2-9	16,5	14,5	12,5	22	1,5	9 - 10,5
CA2-11	20	18	16	22	1,5	11 - 13
CA2-14	22	20	18	22	1,5	14 - 16
CA2-17	26	24	22	22	1,5	17 - 19
CA2-20	29	27	25	35	1,5	20 - 22
CA2-24	33	31	29	30	1,5	24 - 26
CA2-28	37	35	33	34	1,5	28 - 30

## RED CAPS

DESCRIPTION	
<b>MATERIAL</b>	POLYTHENE (LDPE)
<b>COLOR</b>	RED
<b>NOTE</b>	

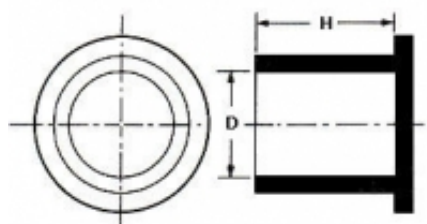

CODE	D	H
CAPR5X13	5	13
CAPR6X10	6	10
CAPR8X10	8	10
CAPR8X16	8	16
CAPR12X16	12	16
CAPR12,7X46	12,7	46
CAPR12,8X20,2	12,8	20,2
CAPR14X20	14	20
CAPR16X15	16	15
CAPR16X20	16	20
CAPR19X33,6	19	33,6
CAPR20X15	20	15
CAPR20X20	20	20
CAPR22X18	22	18
CAPR24X18	24	18
CAPR25,4X55,6	25,4	55,6
CAPR32X58,5	32	58,5
CAPR38,1X44,5	38,1	44,5

## LARGE HEAD HIGH CAPS

DESCRIPTION	
<b>MATERIAL</b>	POLYTHENE (LDPE)
<b>COLOR</b>	NATURAL
<b>NOTE</b>	BSP column also valid for type thread NPT

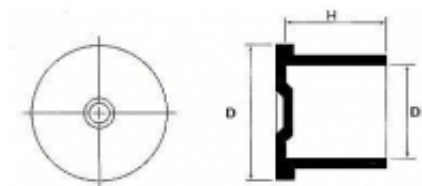

CODE	D	D1	H	THREAD	BSP
CTL1/8"	16,8	10,1	9,7		1/8"
CTL1/4	20,6	13,5	13,5		1/4"
CTL3/8"	23,9	17	13,5		3/8"
CTL1/2	27,7	21,2	18,3		1/2"
CTL3/4"	33,3	26,5	19,1		3/4"
CTL1"	39,6	33,3	23,6		1"
CTL1,1/4"	49,3	42	24,6		1 1/4"
CTL1,1/2"	54,9	48,1	24,6		1 1/2"
CTL2"	66,6	60,2	26,2		2"
CTLM10	17,5	9,8	9,7	M10	
CTLM12	19,5	11,8	12	M12	
CTLM14	21,5	13,7	12	M14	
CTLM16	23,5	15,7	12	M16	
CTLM18	25,5	17,7	12	M18	
CTLM20	27,5	19,7	14,1	M20	
CTLM22	29,5	21,7	14,1	M22	
CTLM33	40,4	32,6	17,5	M33	
CTLM38	44,5	37,6	19	M38	
CTLM42	49,5	41,7	19	M42	

## ORF CAPS

DESCRIPTION	
<b>MATERIAL</b>	POLYTHENE (LDPE)
<b>COLOR</b>	BLUE
<b>NOTE</b>	UNF column also valid for type thread JIC

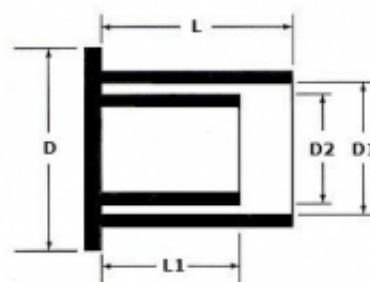

CODE	D	D1	D2	L	L1	UNF
ORF9/16"	22,2	19,5	12,7	14,7	8,3	9/16"
ORF11/16"	25	22,9	15,1	17,1	9,4	11/16"
ORF13/16"	29,4	26,8	19,1	21	10,9	13/16"
ORF1	34,9	31,9	23	23,4	13,5	1"
ORF1,3/16"	41,3	38,9	27,8	26,2	14,5	1.3/16"
ORF1,7/16"	46,8	45,8	34,1	27,8	14,7	1,7/16"
ORF1,11/16"	54	53,2	40,5	27,8	14,7	1.11/16"
ORF2	68,3	64	47,6	27,8	14,7	2"

## PULL-TAB HOSE PLUGS

DESCRIPTION	
<b>MATERIAL</b>	EVA (Ethylene Vinyl Acetate)
<b>COLOR</b>	YELLOW
<b>NOTE</b>	

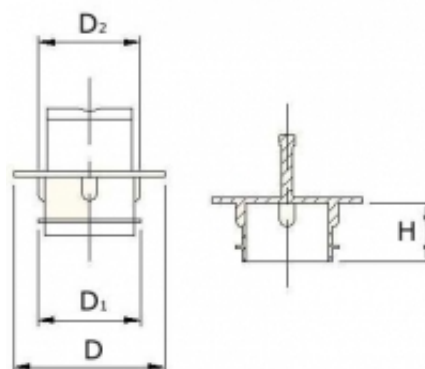

CODE	D	D1	D2	H
TT15	11	5,3	5,1	11
TT110	18	10,4	10,2	11
TT115	21,5	15,4	15,2	11
TT119	28,5	19,4	19,2	11

## PRESSION PLUG

DESCRIPTION	
<b>MATERIAL</b>	POLYTHENE
<b>COLOR</b>	RED
<b>NOTE</b>	

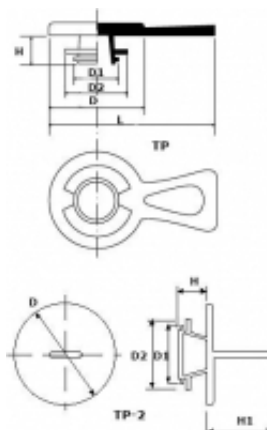

CODE	D	D1	D2	H	H1	L	THREAD	GAS	UNF
TP1/8	19	9	13,2	9		34	M10 - M12	1/8"	7/16"
TP1/4	22,7	9,8	16,5	7		40	M14 - M16	1/4"	1/2"
TP3/8	30	13	19,5	8		47	M18 - M20	3/8"	3/4"
TP1/2	34,3	16,3	23,8	9,5		51,4	M22 - M24	1/2"	7/8"
TP3/4	40	19	27,6	9,5		57	M26 - M28	3/4"	1.1/16"
TP1	45	29,9	34,5	10		62	M30 - M36	1"	1.1/4"
TP2-1/8	19	9	13,2	9	21,2		M10 - M12	1/8"	7/16"
TP2-1/4	22,7	9,8	16,5	7	21,2		M14 - M16	1/4"	1/2"
TP2-3/8	30	13	19,5	8	21,4		M18 - M20	3/8"	3/4"
TP2-1/2	34,3	16,3	23,8	9,5	21,4		M22 - M24	1/2"	7/8"
TP2-3/4	40	19	27,6	9,5	21,5		M26 - M28	3/4"	1.1/16"
TP2-1	45	29,9	34,5	10	21,6		M30 - M36	1"	1.1/4"

## PRESSION PLUGS WITH 1 INSERT

DESCRIPTION	
<b>MATERIAL</b>	POLYTHENE (LDPE)
<b>COLOR</b>	YELLOW
<b>NOTE</b>	

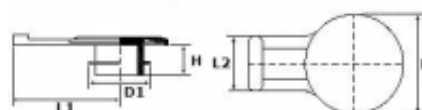

CODE	D	D1	H	L1	L2	INSERITO IN UN FILETTO MASCHIO	PITCH
TSFL2-12	16	11,8	7	18	12	M12x1,5	1,5
TSFL2-14	19	13,8	7	19,5	12	M14x1,5	1,5
TSFL2-16	21,5	15,8	7	23	14	M16x1,5	1,5
TSFL2-18	25	17,8	7,5	25	14	M18x1,5	1,5
TSFL2-20	27	19,8	7,5	26	14	M20x1,5	1,5
TSFL2-22	29	21,8	7,5	31	14	M22x1,5	1,5
TSFL2-24	30	23,8	7,5	31	14	M24x1,5	1,5
TSFL2-26	32	25,8	8	31	14	M26x1,5	1,5
TSFL2-30	35	29,5	10	31,5	14	M30x2	2
TSFL2-36	40	35,5	10	34	14	M36x2	2
TSFL2-42	50	41,5	10	40	15	M42x2	2
TSFL2-45	50	44,5	10	40	15	M45x2	2
TSFL2-52	60	51,5	10	45	15	M52x2	2



## PRESSION PLUGS WITH 2 INSERTS

DESCRIPTION	
<b>MATERIAL</b>	POLYTHENE (LDPE)
<b>COLOR</b>	NATURAL
<b>NOTE</b>	

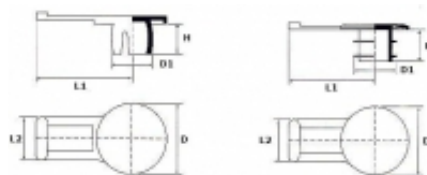

CODE	D	D1	H	L1	L2	INSERITO IN UN FILETTO MASCHIO
TSFL10	16,5	9,5	8,5	26,5	12	M10
TSFL10/2	16	9,5	8	23,5	12	M10
TSFL12	19,5	11,2	8,5	26,5	12	M12
TSFL12/2	19	11,1	8	25	12	M12
TSFL14	21,5	13,4	7	27	12	M14
TSFL14/2	21	13,1	10	26	12	M14
TSFL16	23,5	15,2	8	27	12	M16
TSFL16/2	24	15,1	11	28,5	14	M16
TSFL22	29,5	21,7	8	31	14	M22
TSFL22/2	29	21,5	11,5	31	14	M22

## PUSH-IN PLUGS

DESCRIPTION	
<b>MATERIAL</b>	POLYTHENE
<b>COLOR</b>	RED
<b>NOTE</b>	

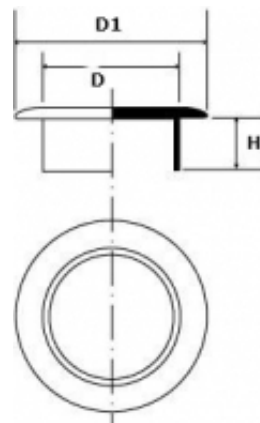

CODE	D	D1	H
PIP7/16	9,5	15,5	7
PIP1/2	11	17	7
PIP11,9	11,9	16,4	6,3
PIP9/16	12,5	20,5	7
PIP5/8	14,3	23,7	6,5
PIP3/4	18,8	24,9	8,6
PIP19,2	19,2	23,8	7
PIP7/8	20,3	26,6	10,4
PIP1	23,5	31	10
PIP1,1/16	24,8	35,5	10
PIP25,5	25,5	30	6,1
PIP30,9	30,9	35	8
PIP45,4	45,4	51	7,5

## PUSH-IN PLUGS TYPE 2

DESCRIPTION	
<b>MATERIAL</b>	POLYTHENE (LDPE)
<b>COLOR</b>	YELLOW
<b>NOTE</b>	GAS column also valid for type thread NPT

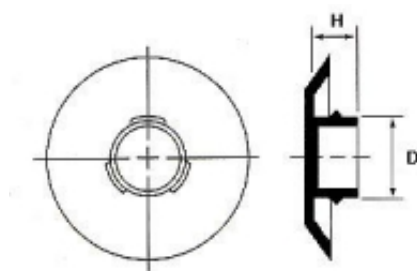

CODE	D	H	GAS	SAE/UNF
PIP2-1/4"	5,2	5,6	-	1/4"
PIP2-5/16"	6,7	6	-	5/16"
PIP2-1/8"	8,2	6	3/8"	1/8"
PIP2-7/16"	9,7	6,9	-	7/16"
PIP2-1/2"	11,1	6,9	1/2"	1/2"
PIP2-9/16"	12,6	7,4	-	9/16"
PIP2-3/8"	14,2	7,4	5/8"	3/8"
PIP2-11/16"	15,5	7,4	-	11/16"
PIP2-3/4"	17,2	7,4	-	3/4"
PIP2-1/2"	18,6	7,4	13/16"	1/2"
PIP2-7/8"	20,3	7,4	-	7/8"
PIP2-1"	23,4	7,4	3/4"	1"
PIP2-1-1/16"	24,7	7,4	-	1-1/16"
PIP2-1-3/16"	27,7	8,6	-	1-3/16"
PIP2-1-1/4"	29,5	8,6	-	1-1/4"
PIP2-1-5/16"	30,9	8,6	1"	1-5/16"
PIP2-1-7/16"	34,5	11,7	-	1-7/16"
PIP2-1-1/2"	35,7	11,7	-	1-1/2"
PIP2-1-5/8"	38,7	11,7	-	1-5/8"
PIP2-1-3/4"	41,9	11,7	-	1-3/4"
PIP2-1-7/8"	45,1	11,7	-	1-7/8"



**PANOZZO s.r.l.**

Via del Calendone n° 50/H

Tel. +39 039 9275 363

FAX. +39 039 9275 321

PEC: panozzosrl@pcert.it

**panozzosrl.com**

